

Data Sheet



Article number: 588Q3C430XE0671

Description: Solenoid valve type Q3C430.XE0.671 3/2 NC
24 VDC orifice 3,0 housing in Stainless AISI 316 Inlet port G1/4"

Measures

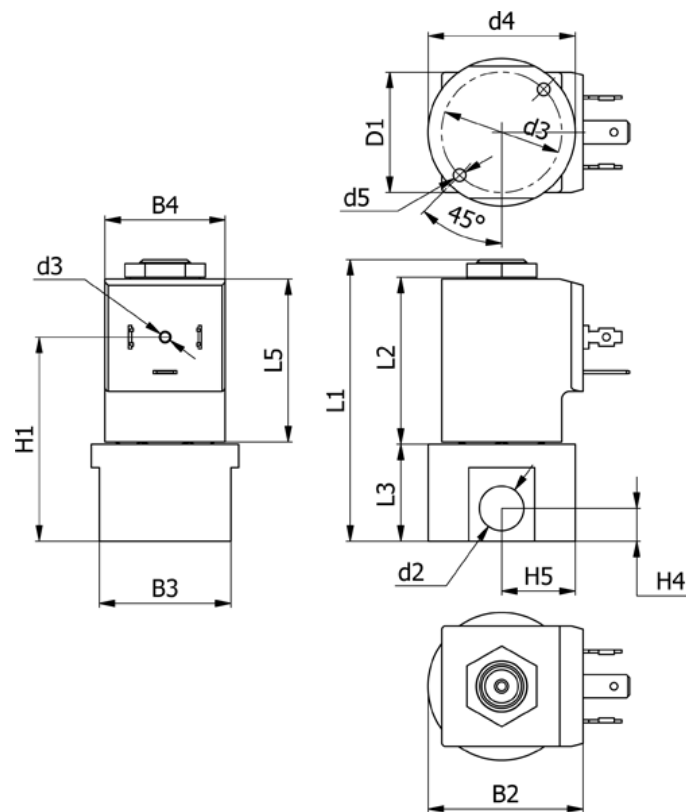

B2 = 40	H1 = 52.5	Voltage = 24 VDC
B3 = 34	H4 = 8.5	
B4 = 31	H5 = 19	
d2 = G1/4"	L1 = 72.6	
d3 = M3x4	L3 = 25	
d4 = 31	L5 = 42.5	
d5 = M4x8	Orifice = 3.0	
Flow = 3.5	Valve function = 3/2 NC	